









MTE 70

	27,00 m		25,00 m		12,80 m (230 kg) 17,00 m (100 kg)
	230 kg		1,40x0,70x1,10 m		90°+90°
	400°		EX Stabilizzatori a estensione laterale idraulica Stabs par vérins extensibles hydrauliquement Laterally extensible hydraulic stabilizers H-Abstützung		3,5 t



Vollabstützung Reichweite über Heck

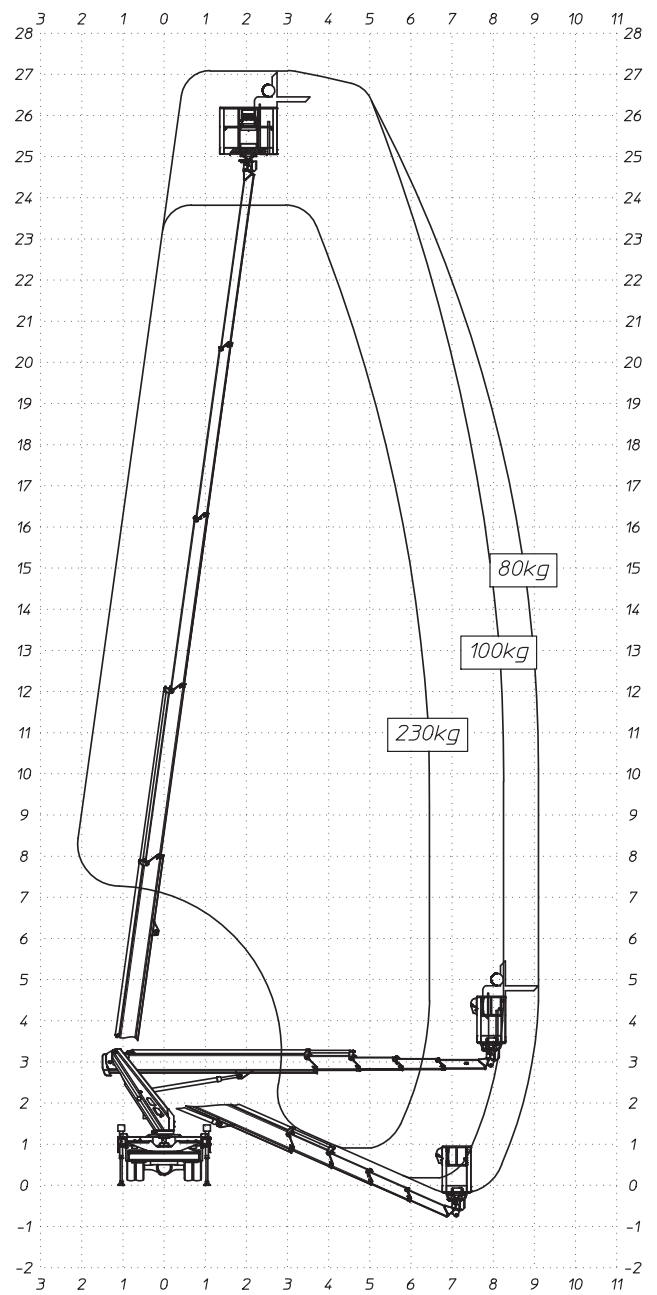
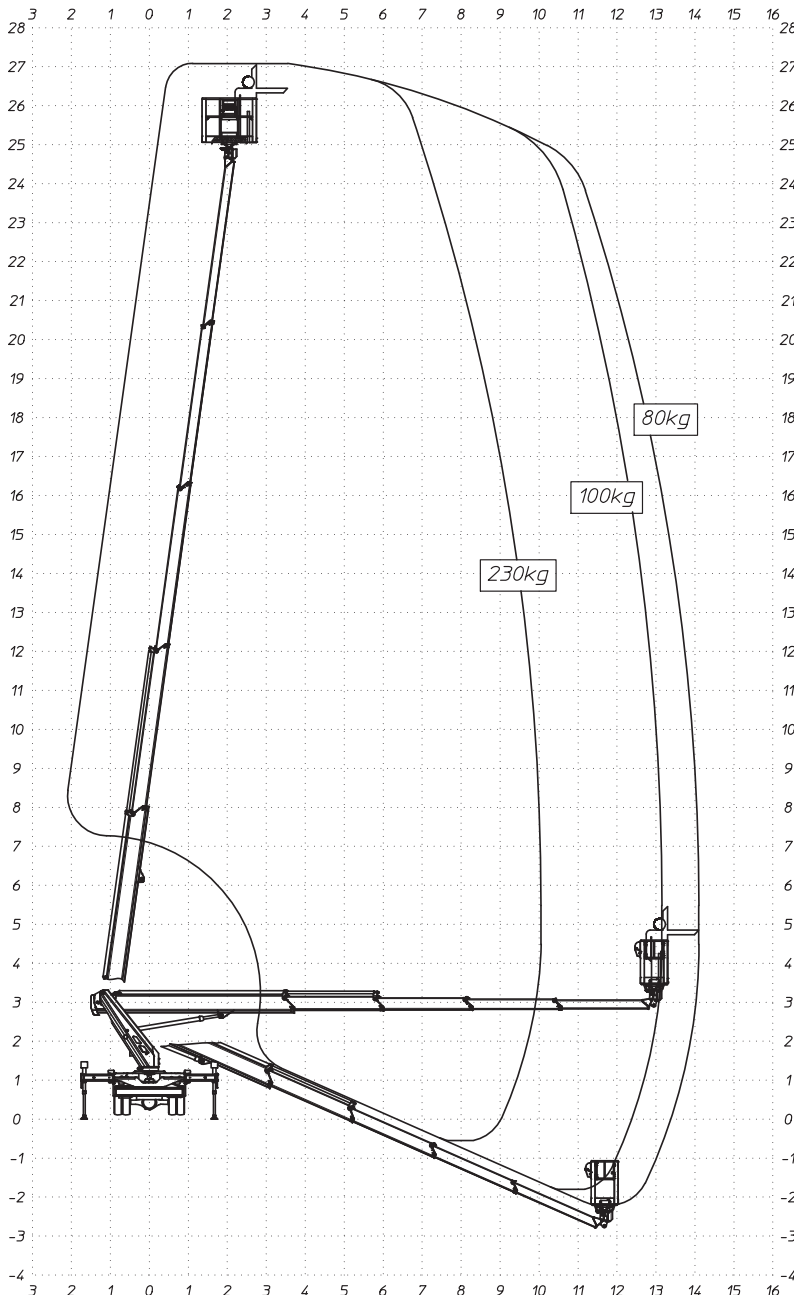